



US0D1055335S

(12) **United States Design Patent**  
**Nielsen et al.**

(10) **Patent No.:** **US D1,055,335 S**

(45) **Date of Patent:** **\*\* Dec. 24, 2024**

(54) **EXTERIOR LIGHTING FOR AIRCRAFTS**

(71) Applicants: **Christian R Nielsen**, Palm Coast, FL  
(US); **Oleksii Antoshyn**, Pribram (CZ);  
**Anton Bondariev**, Dobris (CZ); **Javier**  
**Gordillo**, Pribram VI (CZ)

(72) Inventors: **Christian R Nielsen**, Palm Coast, FL  
(US); **Oleksii Antoshyn**, Pribram (CZ);  
**Anton Bondariev**, Dobris (CZ); **Javier**  
**Gordillo**, Pribram VI (CZ)

(\*\*) Term: **15 Years**

(21) Appl. No.: **29/931,815**

(22) Filed: **Mar. 8, 2024**

(51) **LOC (14) Cl.** ..... **26-06**

(52) **U.S. Cl.**  
USPC ..... **D26/28**

(58) **Field of Classification Search**

USPC ..... D26/28, 29, 30, 31, 32, 33, 34, 35, 36,  
D26/37, 38, 39, 139

CPC .. F21S 43/00; F21S 41/32; F21S 41/36; F21S  
41/50; F21S 41/26; F21S 41/00; F21S  
41/20; F21W 2102/00; F21W 2103/00;  
F21W 2103/10; F21W 2104/00

See application file for complete search history.

(56) **References Cited**

**U.S. PATENT DOCUMENTS**

D639,502 S *	6/2011	Heilaneh	.....	D26/139
D658,806 S *	5/2012	Huang	.....	D26/139
D683,495 S *	5/2013	Yaffe	.....	D26/139
D741,928 S *	10/2015	Huang	.....	D26/38
D753,006 S *	4/2016	Deyaf	.....	D26/37
D753,327 S *	4/2016	Miki	.....	D26/37
D760,414 S *	6/2016	Brown	.....	D26/37
D766,477 S *	9/2016	Ma	.....	D26/37
D771,853 S *	11/2016	Ott	.....	D26/37
D804,089 S *	11/2017	Dollar	.....	D26/139

D828,939 S *	9/2018	Bo	.....	D26/38
D855,227 S *	7/2019	Becker	.....	D26/37
D868,359 S *	11/2019	del Rosario	.....	D26/139
D869,033 S *	12/2019	Kim	.....	D26/36
D880,764 S *	4/2020	He	.....	D26/139
D902,459 S *	11/2020	Ni	.....	D26/38
D903,172 S *	11/2020	Ni	.....	D26/38
D922,636 S *	6/2021	Pierson	.....	D26/37
D924,453 S *	7/2021	Guo	.....	D26/37
D930,201 S *	9/2021	Shang	.....	D26/37
D930,867 S *	9/2021	Ormsbee	.....	D26/37

(Continued)

*Primary Examiner* — Sheryl Lane

*Assistant Examiner* — Kathryn Elizabeth Chambers

(74) *Attorney, Agent, or Firm* — Barry Choobin; Patent  
360

(57) **CLAIM**

The ornamental design for an exterior lighting for aircrafts,  
as shown and described.

**DESCRIPTION**

FIG. 1 is a perspective view of an exterior lighting for  
aircrafts, showing my new design;

FIG. 2 is a front view thereof;

FIG. 3 is a rear view thereof;

FIG. 4 is a right side view thereof;

FIG. 5 is a left side view thereof;

FIG. 6 is a top view thereof;

FIG. 7 is a bottom view thereof;

FIG. 8 is another perspective view thereof, in which a lamp  
is shown in an open position.

FIG. 9 is an enlarged view of portion 9 indicated in FIG. 1.

FIG. 10 is an enlarged view of portion 10 indicated in FIG.  
3; and,

FIG. 11 is an enlarged view of portion 11 indicated in FIG.  
4.

The broken lines depict portions of the exterior lighting for  
aircrafts that form no part of the claimed design.

**1 Claim, 11 Drawing Sheets**

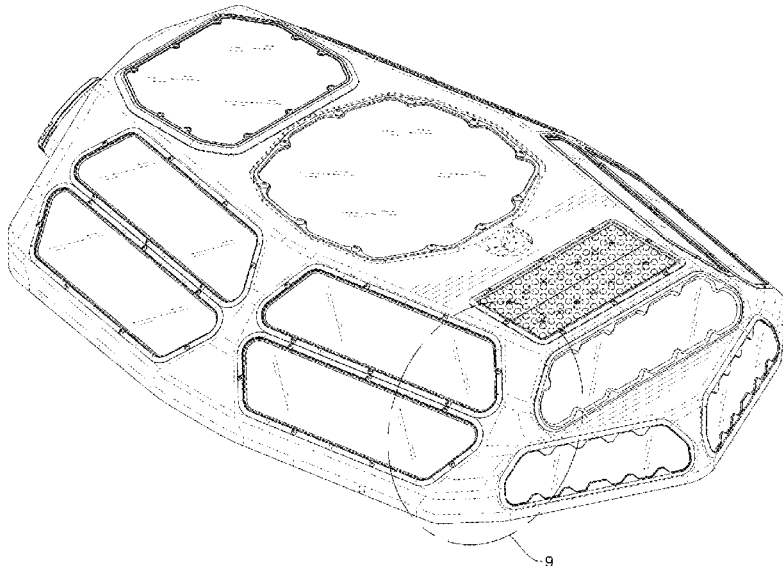

(56)

**References Cited**

U.S. PATENT DOCUMENTS

D936,878	S	*	11/2021	Tran	.....	D26/37
D940,935	S	*	1/2022	Wojan	.....	D26/37
D949,443	S	*	4/2022	Liang	.....	D26/37
D975,894	S	*	1/2023	Bian	.....	D26/37
D1,005,537	S	*	11/2023	Zhu	.....	D26/28
D1,005,545	S	*	11/2023	Lee	.....	D26/80
D1,009,329	S	*	12/2023	Wu	.....	D26/37
D1,012,344	S	*	1/2024	Yu	.....	D26/85
D1,013,233	S	*	1/2024	Hong	.....	D26/37
D1,018,926	S	*	3/2024	Xiao	.....	D26/37
D1,024,410	S	*	4/2024	Ogura	.....	D26/89
D1,027,285	S	*	5/2024	Conway	.....	D26/139
D1,030,118	S	*	6/2024	Stanford	.....	D26/76
D1,035,066	S	*	7/2024	Tian	.....	D26/139

\* cited by examiner

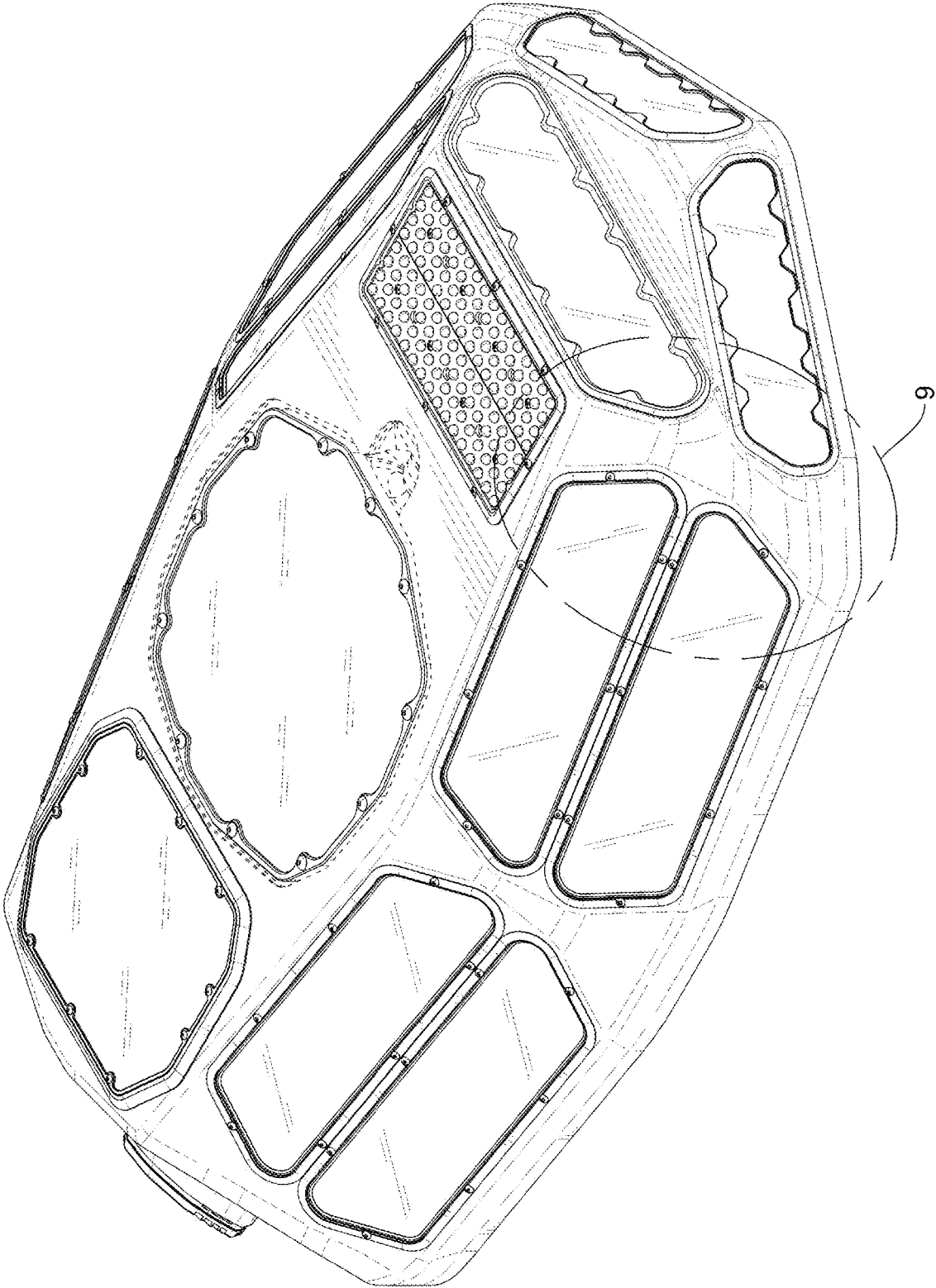

FIG. 1

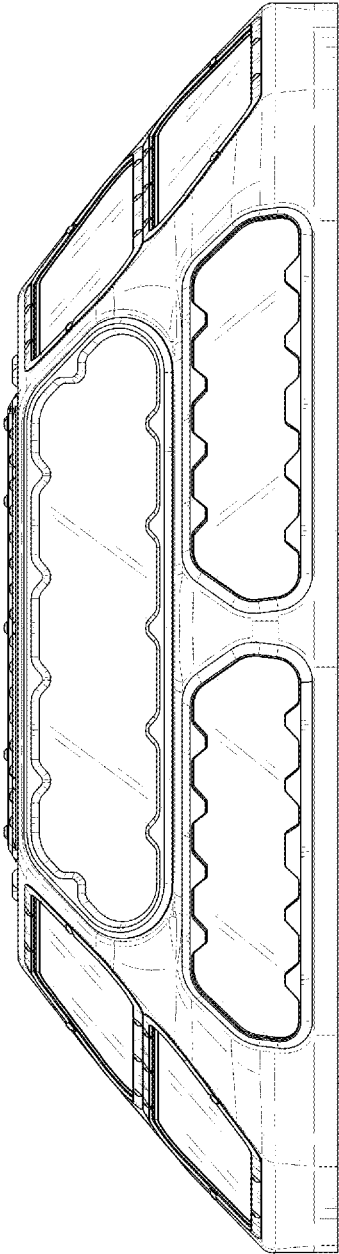

FIG. 2

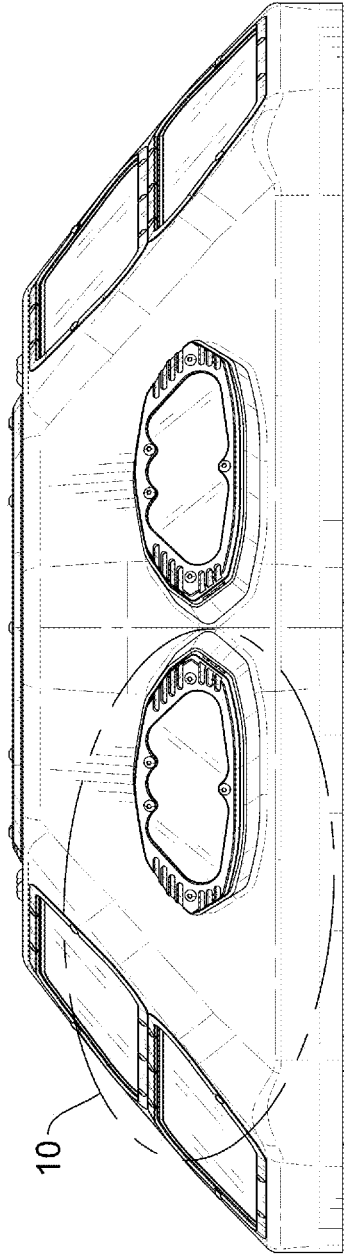

FIG. 3

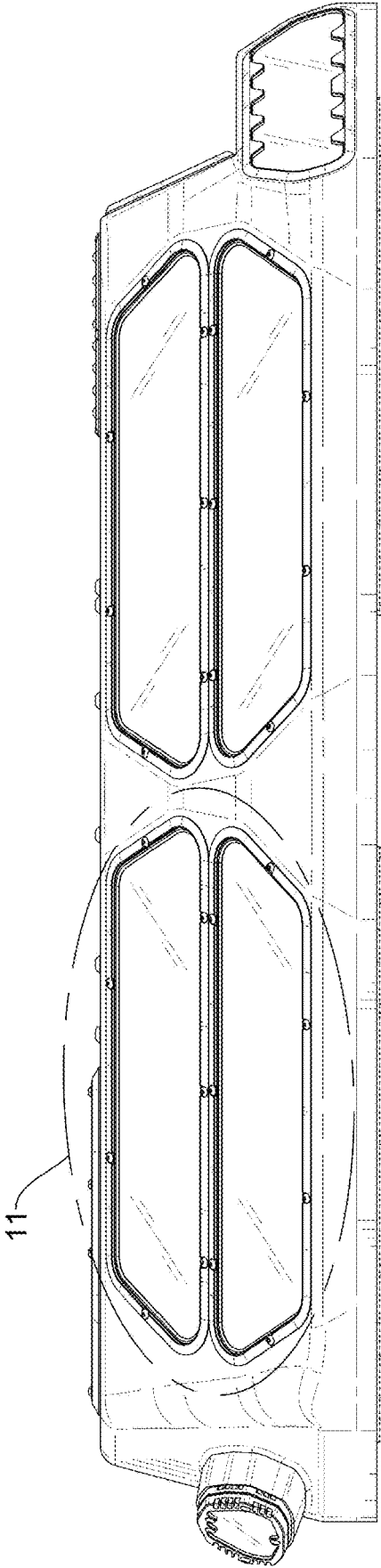

FIG. 4

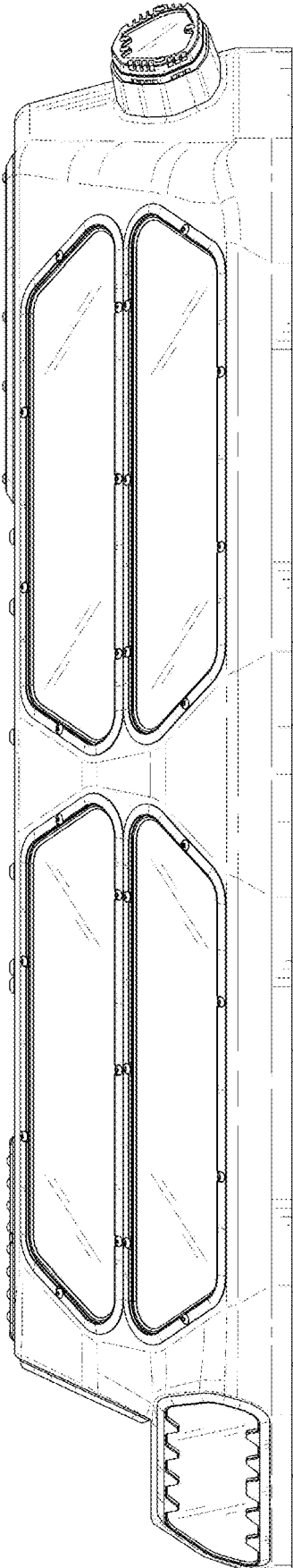

FIG. 5

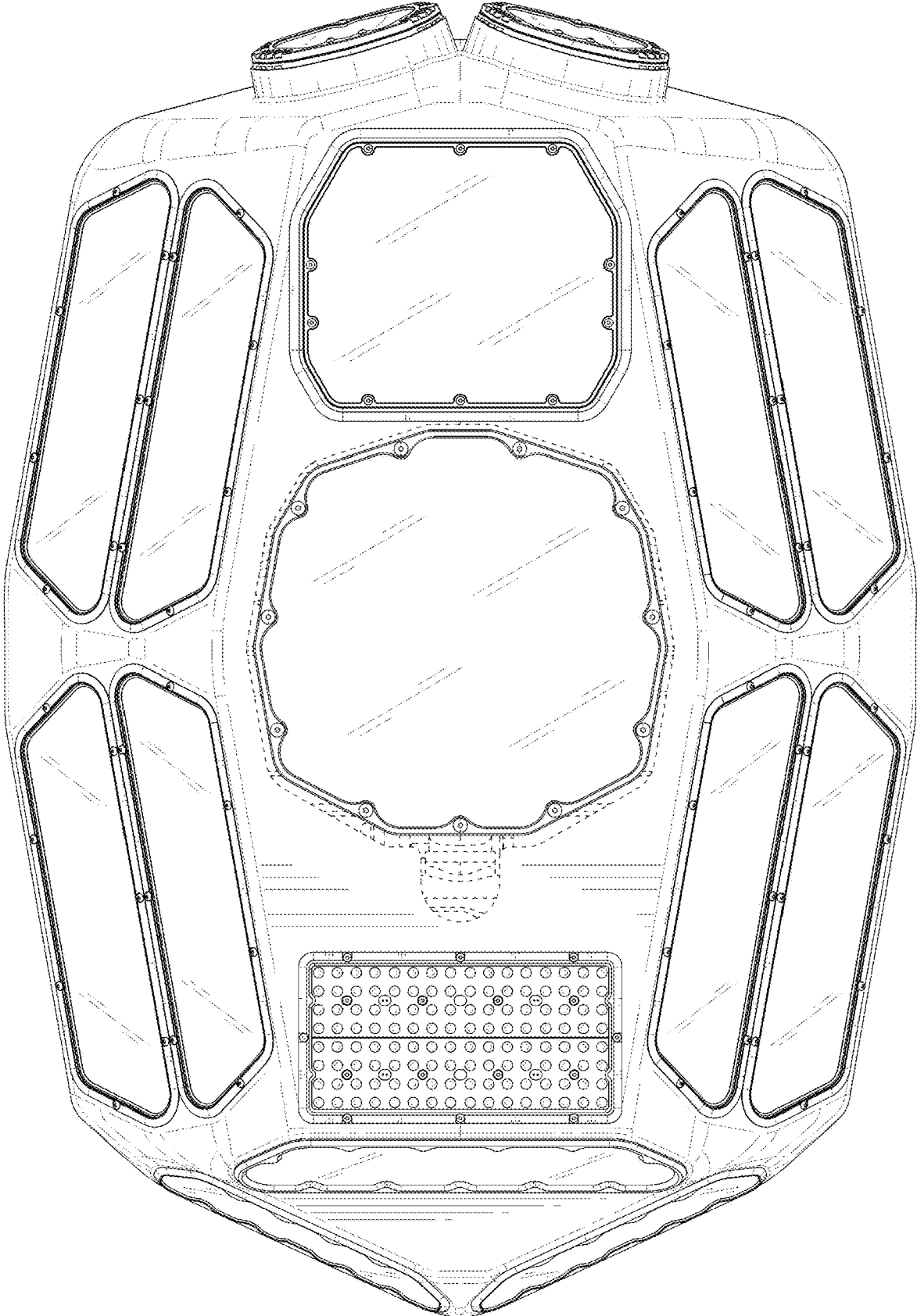

FIG. 6

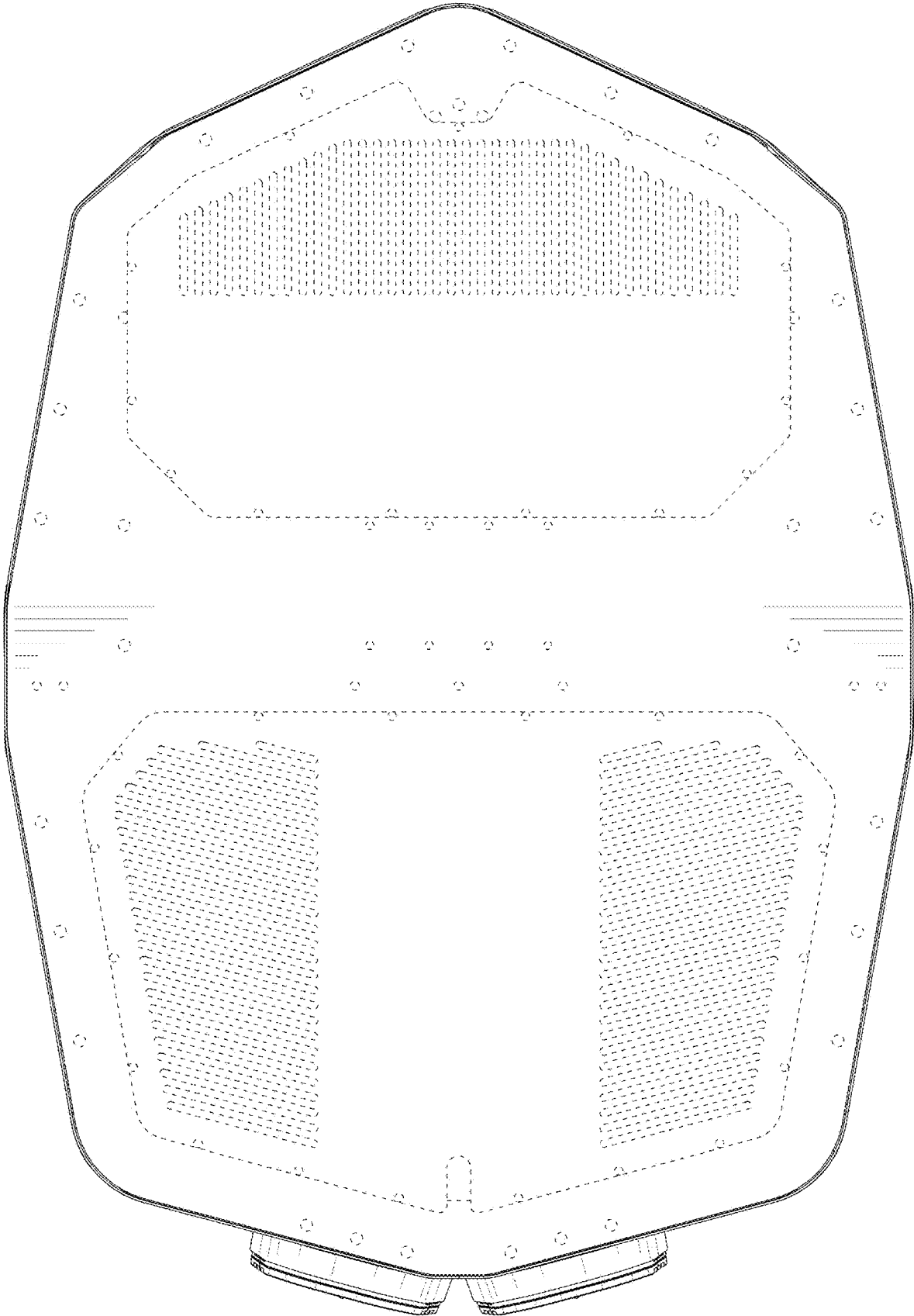

FIG. 7

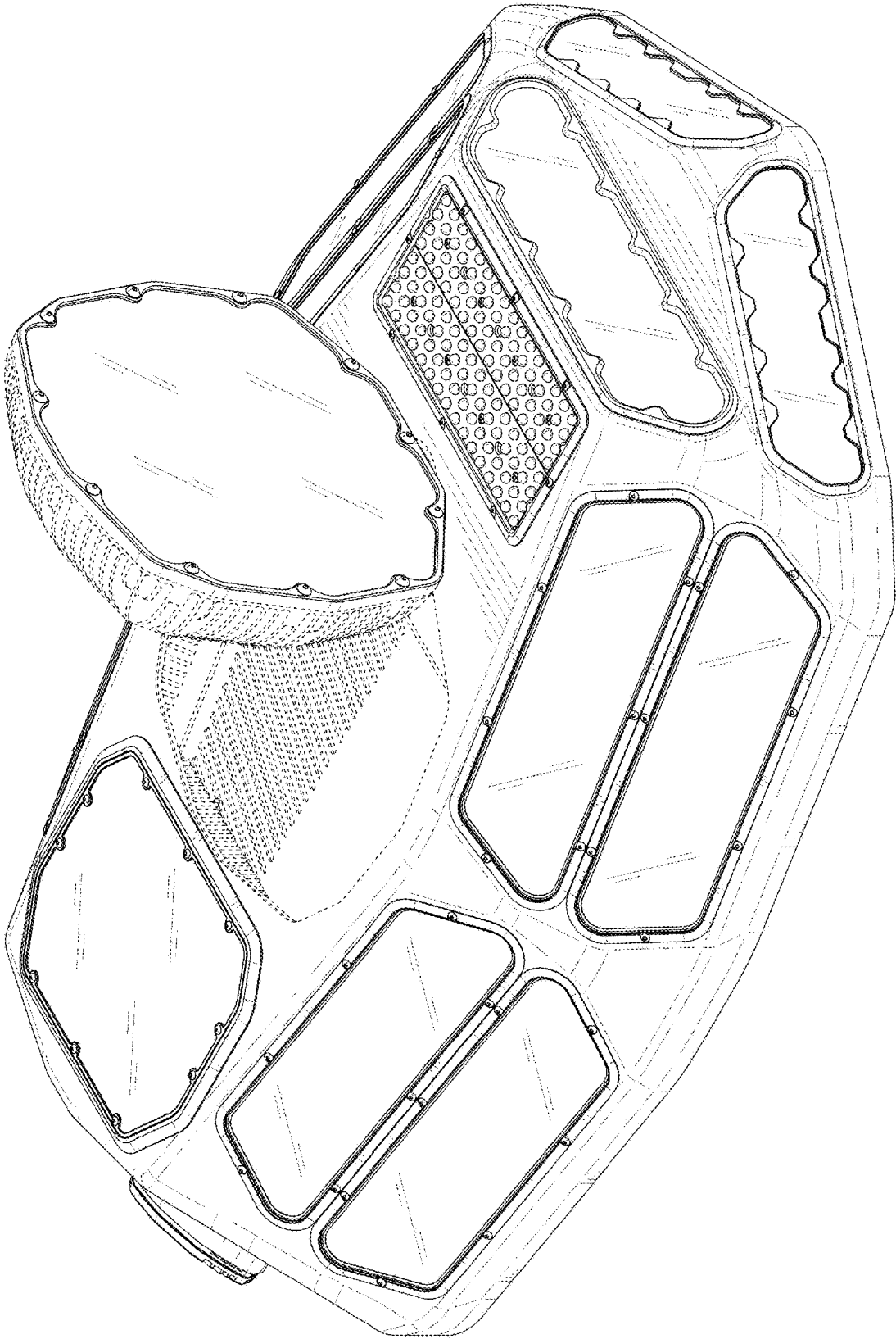

FIG. 8

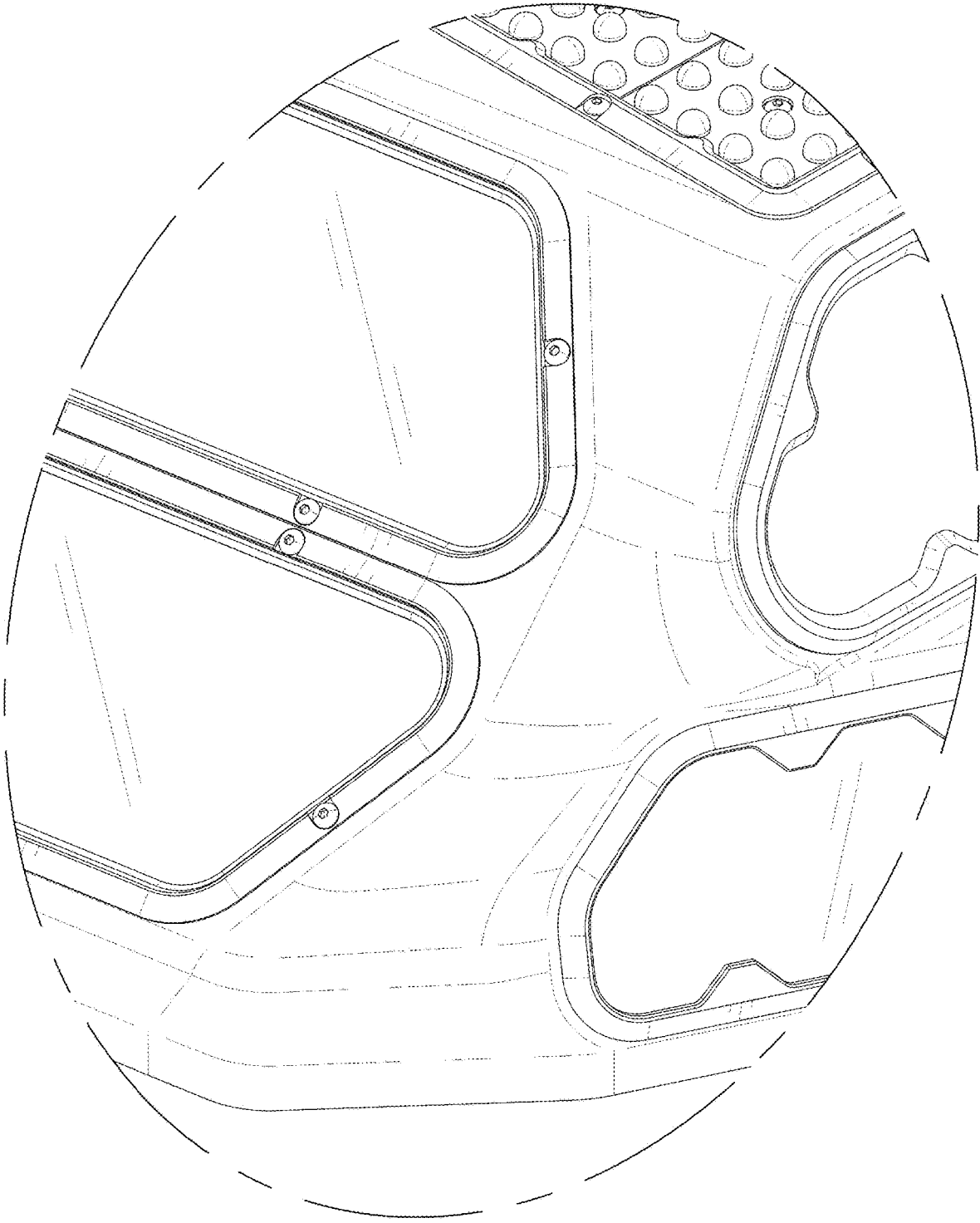

FIG. 9

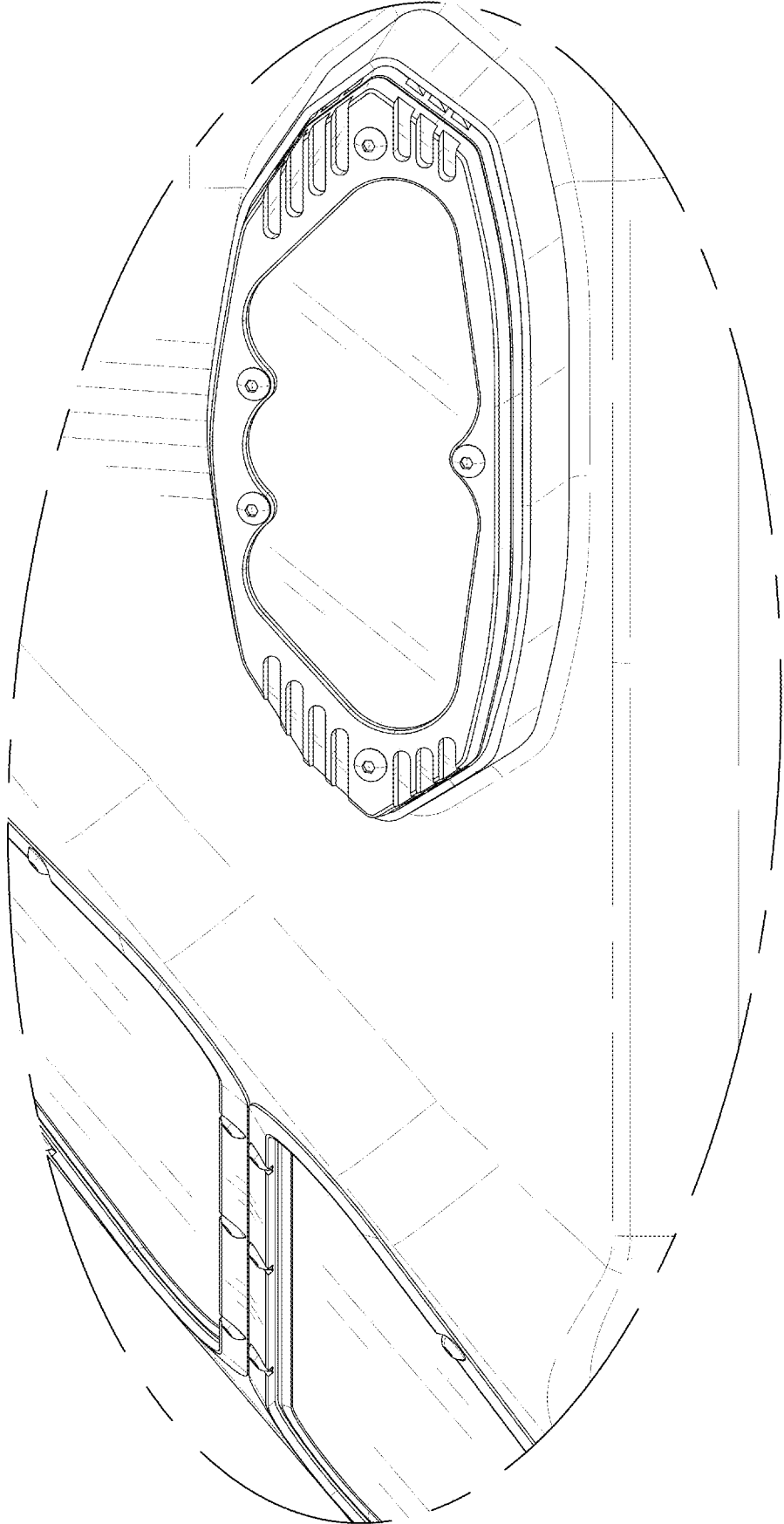

FIG. 10

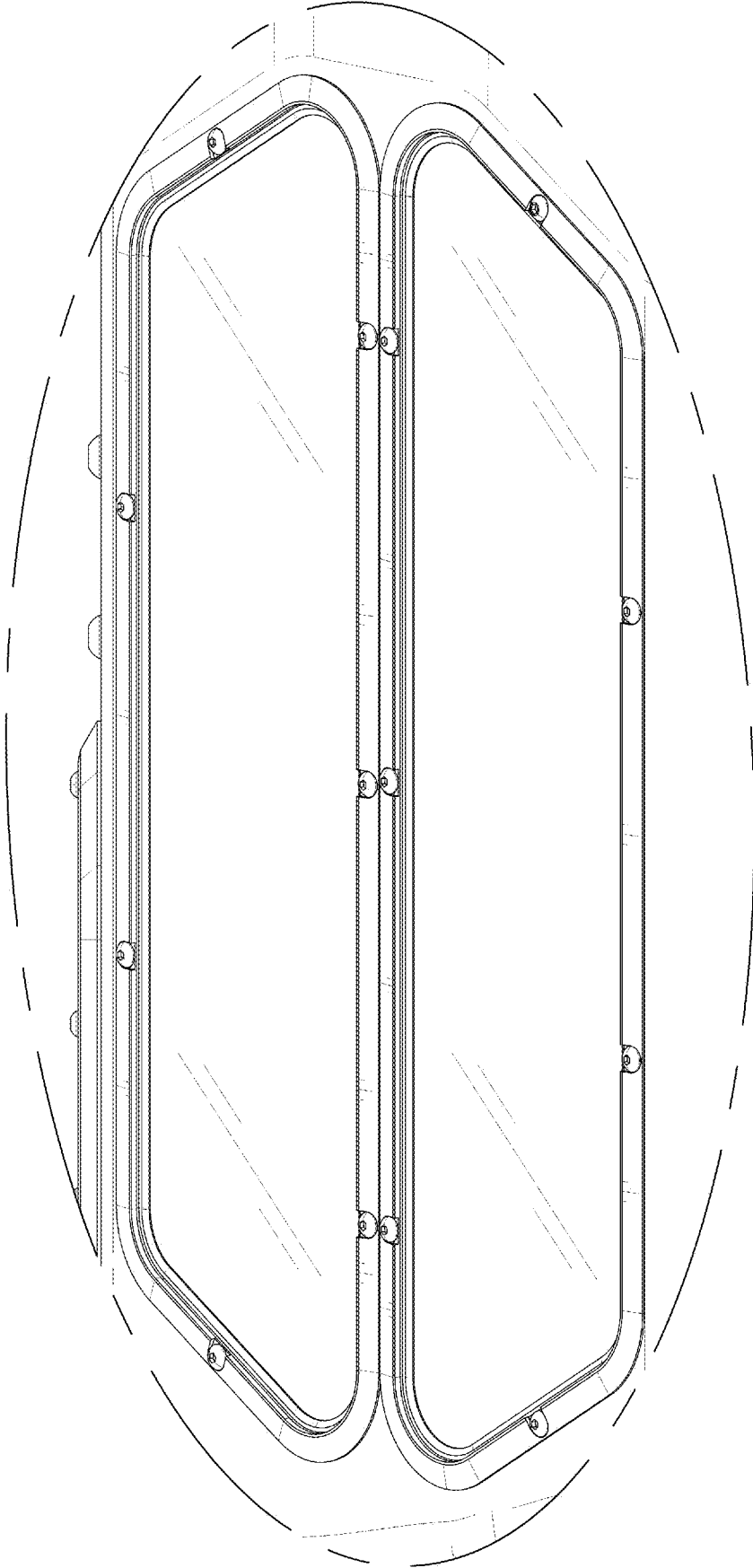

FIG. 11